





CATÁLOGO DE APLICAÇÃO

LINHAS AGRÍCOLA E CONSTRUÇÃO





BIAGIO
TURBOS

SOBRE OS TURBOS BIAGIO



A BIAGIO TURBOS	05	
IDENTIFICAÇÃO	06	
GARANTIA	07	
TECNOLOGIA	08	

3

APLICAÇÃO POR MARCA

CATERPILLAR	10	
CBT		
DYNAPAC		
FIAT ALLIS		
FORD NEW HOLLAND		
IVECO	11	
J. I. CASE		
JOHN DEERE		
KOMATSU		
L.S. TRACTOR		
MAHINDRA		
MASSEY FERGUSON/ PERKINS	12	
METASA		
MÜLLER		
NEW HOLLAND		
RANDON		
SCANIA		
VALTRA/VALMET	13	
VOLVO		

APLICAÇÃO POR CATEGORIA

LINHA AGRÍCOLA	13	
LINHA CONSTRUÇÃO	19	

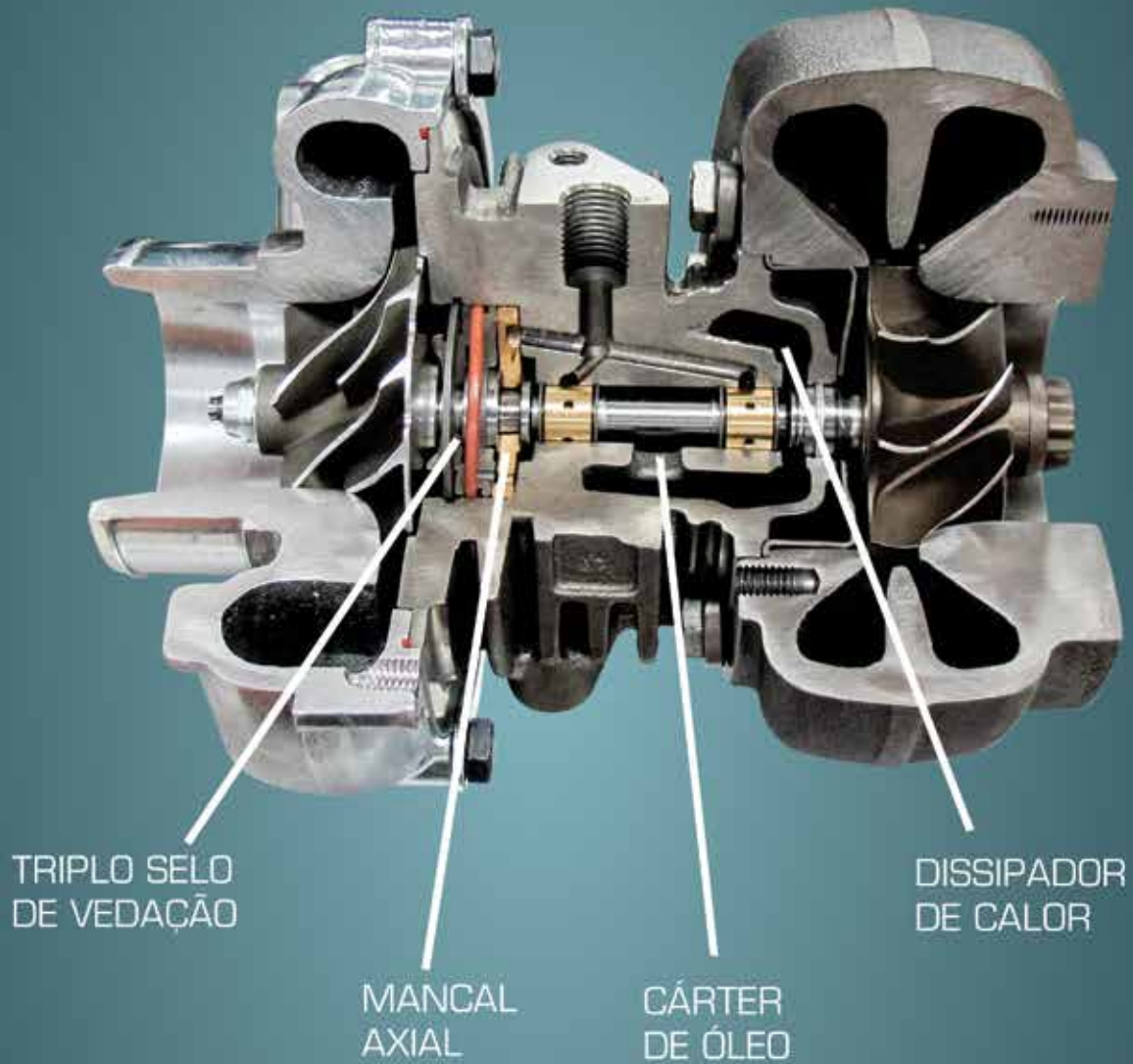

TRIPLO SELO DE VEDAÇÃO

MANCAL AXIAL

CÁRTER DE ÓLEO

DISSIPADOR DE CALOR

SAIBA POR QUE OS TURBOCOMPRESSORES BIAGIO SÃO OS MELHORES DO MERCADO!

TRIPLO SELO DE VEDAÇÃO



Não vaza óleo para o sistema de admissão, mesmo que o motor esteja com restrição no filtro de ar.

Não suja o intercooler por vazamento de óleo vindo do turbo.

Reduz o desgaste do motor.

MANCAL AXIAL COM MAIS PONTOS DE APOIO



Evita a quebra prematura dos componentes internos, quando o freio motor for acionado ou por qualquer ação que possa causar esforço axial.

CÁRTER DE ÓLEO



Previne contra os danos ao eixo central em decorrência de partida fria e/ou parada quente.

DISSIPADOR DE CALOR



Protege o conjunto rotativo contra desgaste prematuro, devido a alta temperatura.



Fundada em 1963, a Biagio Turbos é uma empresa 100% brasileira, que possui soluções próprias e inovadoras para o desenvolvimento de seus turbocompressores. Com projetos específicos para cada tipo de aplicação, o desenvolvimento segue de acordo com as exigências do mercado, características e condições de uso do motor.

A Biagio possui estrutura capaz de produzir internamente todos os principais componentes de seus turbocompressores, o que permite total controle de seu processo de fabricação para garantir a qualidade de seus produtos.

Atualmente, estabelecida em modernas instalações, a empresa possui uma área total de 42.000m², e investe constantemente em tecnologia para inovar e oferecer os melhores turbocompressores ao mercado.

São diversas aplicações atendidas pelos produtos Biagio, como linha automotiva, caminhões, ônibus, pick-ups, tratores, máquinas de terraplanagem, colheitadeiras, motores industriais, geradores, marítimos, entre outros.

QUAL A IMPORTÂNCIA DE IDENTIFICAR O TURBO CORRETAMENTE?

Com a evolução tecnológica dos motores e a busca constante pela melhoria de performance, o dimensionamento do turbo está cada vez mais rigoroso de acordo com a aplicação. É incorreto afirmar que determinado turbo, por apresentar dimensões que aparentam ser mais eficientes, efetivamente apresentará bons resultados. O dimensionamento e aplicação são frutos de estudos aprofundados que visam obter o melhor aproveitamento do motor.



IDENTIFICAÇÃO DO TURBOCOMPRESSOR

Todos os turbos produzidos pela Biagio contém na placa de identificação quatro informações:

•HDM (nomenclatura comercial);

•P/N (part number);

Corresponde ao código da tabela de aplicação Biagio Turbos, com este número é possível identificar a aplicação correta e o modelo do turbo;

•S/N (número de série que informa a data de fabricação);

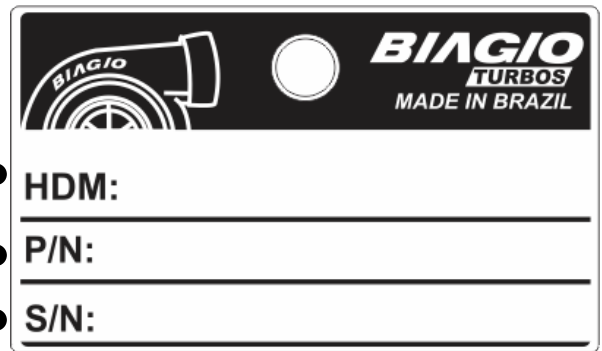

6

IDENTIFICAÇÃO DA SÉRIE DO TURBOCOMPRESSOR

É possível rastrear o turbo a partir do número de série contido na última linha da plaqueta de identificação. Este rastreamento foi criado para assegurar a qualidade e o comprometimento que a Biagio tem com seus clientes. Cada peça produzida possui seu próprio número de identificação e com isso é possível averiguar prováveis falhas do processo de manufatura e eliminá-las.

Para identificar o turbo a partir do número de série basta conferir as letras e números baseados na tabela abaixo:

RC	RR	01	123
Ano	Mês	Dia	Nº da peça

Exemplo:
Nº DE IDENTIFICAÇÃO: RCRR01-123

Tabela de conversão

R	E	P	U	B	L	I	C	A	S
1	2	3	4	5	6	7	8	9	0

Data de produção	RC - 18 (2018) RR - 11 (Novembro) 01- Dia
Número da peça	123

SEM LETRINHAS MIÚDAS!



**TODOS OS TURBOS
PARA AS LINHAS
AGRÍCOLA E AMARELA
POSSUEM 18 MESES DE GARANTIA**

Tecnologia desenvolvida especialmente para as linhas Agrícola e Amarela!

Os turbos das linhas agrícola e amarela, foram desenvolvidos com a carcaça central aletada, isso porque os veículos destas linhas trabalham em condições extremas e o turbo é muito exigido, fazendo com que ele aqueça com mais rapidez que o turbo que é aplicado em outras linhas. Este desenvolvimento ajuda no resfriamento da carcaça e contribui para a proteção do conjunto central.



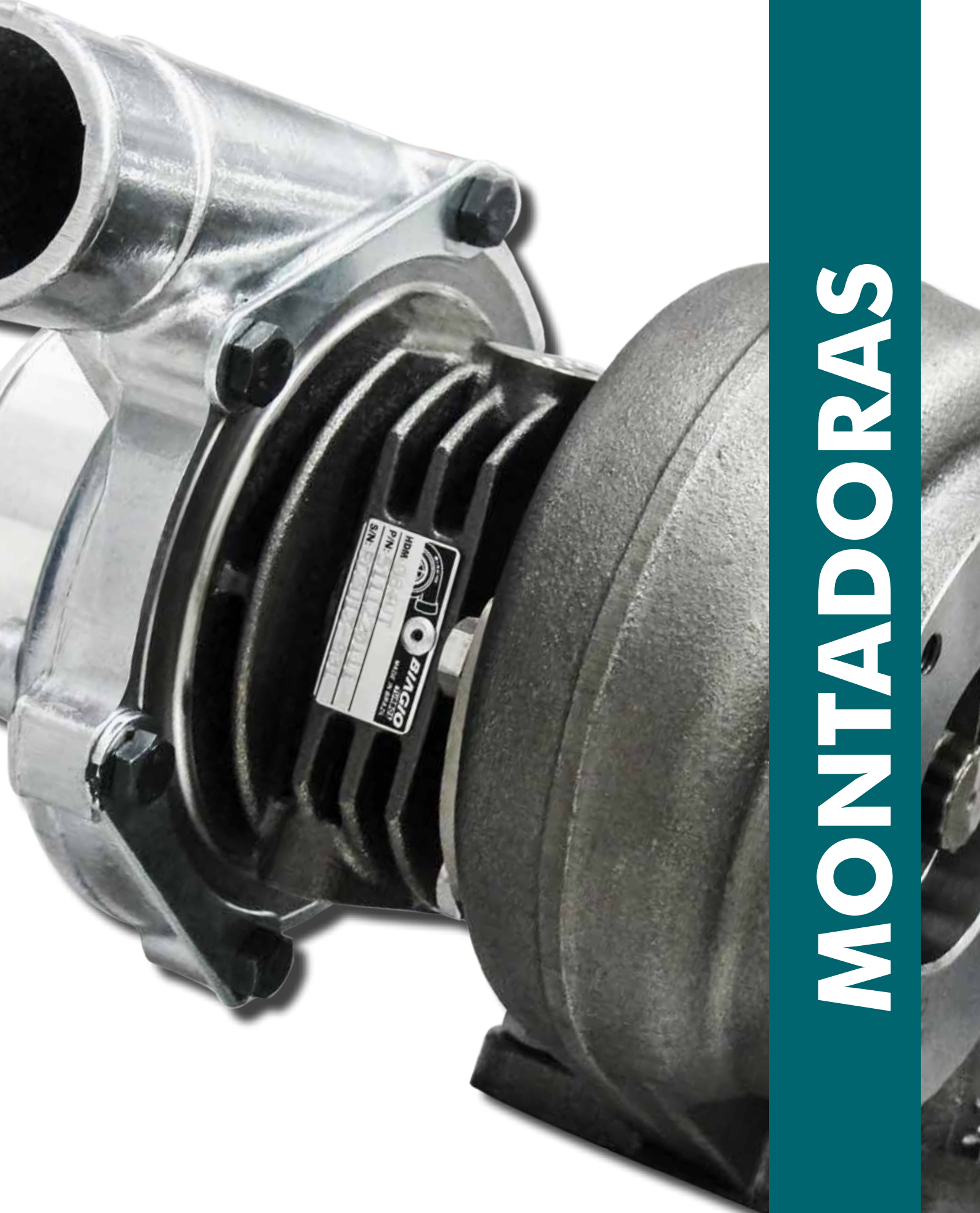

MONTADORAS

CATERPILLAR

VEÍCULO	MOTOR	HDM BIAGIO	MOD. BIAGIO	O.E.M.	P/N GARRET	P/N BORG W.	P/N HOLSET	PÁG. FOTO
PATROL 112H ESCAVADEIRA 325	3116DIT	078CT	TUNA 78	0R6240 4P5523	*	199288	*	22-B
8N1414	3306	108GT	TUNA 96	8N1441	*	184662	*	22-G
950B/ 955X /5X/130G/ 9308 888/ 229/936E/ 963/D4E-AS GERADOR	3304/3304DIT	152CAT	TUNA 20	1W5160G /7N1709 7N4651G/ 7N9851	409410-0008/6	*	*	23-B
120G/ 950/ 518/ E207/ E240MHI/ 120G/ 225/ SMFS	3304/3304DIT	175AT	TUNA 20	4N6858 4N6859 4N9714	409410-0002/2	*	*	23-F
ESCAVADEIRA 315C/ 312C/ 320L	3046	315AT	TUNA 10	1166709 1177867	*	*	*	24-A
D6D/ 966C 120G/ 140G	CAT 3306	319AT	TUNA 94	6N1571/ 4N8969/ 0R5809	*	310130 159623 180189	*	24-B
ESCAVADEIRA 320B/ 320C/ 320L	3066	320AT	TUNA 10	517582 / 517952 / 518018	*	*	*	24-C
140G/ D6D-DD/ 966-C	3006	373AT	TUNA 94	0R5807 / N7748	*	184119 3101135	*	24-E
0R5811-8N9247	3006	373BT	TUNA 94	0R5811 / 8N9247	*	185841/313092	*	24-F
RETROESCAVADEIRA 416E	PERKINS 4.4L	416AT	TUNA 16	237-3786 / 2674A226 - 2674A432 / 2674A877	711736-0026 / 711736-5026	*	*	24-G
4N9618	3006	504CT	TUNA 82	4N9618	*	180287	*	24-H
CAT. IDS 924 / T54F	3114	924FT	TUNA 10	114-3601E / 0R6900	*	317817/ 167560/467560	*	25-B
CARREGADEIRA 924G	PERKINST6.60	940AT	TUNA 30	2674A090	52234-50014	*	*	25-C

CBT

VEÍCULO	MOTOR	HDM BIAGIO	MOD. BIAGIO	O.E.M.	P/N GARRET	P/N BORG W.	P/N HOLSET	PÁG. FOTO
TRATOR 8440 (ADAP) / URSUS 6012/ 6014	MWM D229-4 - 6012 4X2 / 6014 - 4X4	050AT	TUNA 20	*	466394-5002	*	*	16-A
TRATOR GD 623 / WA320	CUMMINS 6CT0220 / W030 /6CT0259 / 6CT8.3L	100NT	TUNA 30	*	465843-5001	*	3590079	17-H
PÁ CARREGADEIRA/ W20E/ 888 CKCA- 25-11GDS23 / PC150/3/ PC150 /5/ GD523	CUMMINS 6BT0003 / 19/18/16 5.9L CUM- MINS 6BT 5.9L	170BT	TUNA 30	*	466563-5003	166592	3528741/ 3534285 / 3522778	23-C

DYNAPAC

VEÍCULO	MOTOR	HDM BIAGIO	MOD. BIAGIO	O.E.M.	P/N GARRET	P/N BORG W.	P/N HOLSET	PÁG. FOTO
CT260	CUMMINS 6CT	100NT	TUNA 30	*	465843-5001	*	3590079	17-H
CA25-11	CUMMINS 6BT0024 5.9L	170BT	TUNA 30	*	466563-5003	166592	3522778 3528741	23-C

FIAT ALLIS

VEÍCULO	MOTOR	HDM BIAGIO	MOD. BIAGIO	O.E.M.	P/N GARRET	P/N BORG W.	P/N HOLSET	PÁG. FOTO
ESCAVADEIRA FH200 T150 / TRATOR	MWM TD 229/6	084VT	TUNA 20	9.0529.201. 0013	465744-5005	198684	3590079	17-B
TRATOR AD14C/ FG65/85 /90 /95/105B E FR140/FR16	CUMMINS 6CT 8.3L	100NT	TUNA 30	3007492	465843-5001	*	3590079	17-H

FORD NEW HOLLAND

VEÍCULO	MOTOR	HDM BIAGIO	MOD. BIAGIO	O.E.M.	P/N GARRET	P/N BORG W.	P/N HOLSET	PÁG. FOTO
TRATOR 8630/8830	MOTOR FORD	084CT	TUNA 20	*	465114-5005	*	*	16-C
TRATOR	IVECO / 8060.25	100MT	TUNA 20	4762527	*	169125	*	17-G
TRATOR 7610	4.4L	107ET	TUNA 10	E6NN-6K682AA	466746-5003	*	3537762	18-B
FB100/FB110/FB100.2/ FB110.2/ TB100/TB80/ TS100/TS110/7630/ 7840/2550 SPEEDRO- WER/4630 /5030/5630/ 6610S/6630 /7010/7740 /8030	FORD	220AT	TUNA 09	83999247 FONNN6K682BA	465153-0003	*	3590079	18-F
CS660	6CTAA	40XW5	TUNA 35	J802888	*	*	*	20-D

IVECO

VEÍCULO	MOTOR	HDM BIAGIO	MOD. BIAGIO	O.E.M.	P/N GARRET	P/N BORG W.	P/N HOLSET	PÁG. FOTO
TRACTOR	8060.24.661 / 8065.24	150MT	TUNA 20	4718129	465640-0021 465640-5005	*	*	18-E

J.I. CASE

VEÍCULO	MOTOR	HDM BIAGIO	MOD. BIAGIO	O.E.M.	P/N GARRET	P/N BORG W.	P/N HOLSET	PÁG. FOTO
PÁ CARREGADEIRA W20D/ W20E	OM366A	100FB	TUNA 20	*	465366-5013	313050	3580266	22-C
580L	4BT	106AT	TUNA 21	J802290	*	*	3536838	22-E
PÁ CARREGADEIRA 821B/ 9250/ W36B	CUMMINS 6CT - 8.3L	100NT	TUNA 30	*	465843-5001	175527	3590079	17-H
PÁ CARREGADEIRA W20/ W20B	OM 352A	100WA	TUNA 30	*	409300-0001	312345	3580252	22-D
PÁ CARREGADEIRA W20E/ 888CK	CUMMINS 6BT - 5.9L	170BT	TUNA 30	J919115	466563-5003	166592	3534285/ 3522778	23-C
MAGNUM 220/ 240/ 270 / 305 / MAGNUM MX220 / MX240 / MX270 / 2388	6CTAA	40XW5	TUNA 35	J537762/ J594800	*	*	3537762	22-D
580M	4BT	580AT		*	*	*	4039339	25-A

JOHN DEERE

VEÍCULO	MOTOR	HDM BIAGIO	MOD. BIAGIO	O.E.M.	P/N GARRET	P/N BORG W.	P/N HOLSET	PÁG. FOTO
COLHEITADEIRA 3520	6090H	300ST		RE551406/ RE531288 / RE532384 / RE531469 / RE534760 / RE533889 / RE551405	*	1380988064	*	19-F
84/ 7500/ 7505/ 7600/ 7800/ 1165A/ 1175A/ 780AG/ MPE/ MW3Q	6068TJ-01/ 6059TJ-02/ 6059TJ-03/ 6559TJ-04	350AT	TUNA 20	RE56617	466007-0006 466007-0001	*	*	20-A
350 SERIES -HI MOUNT/ ESCAVADEIRA 350	6068T 116/137CV	350BT	TUNA 20	RE60074/ RE60388	471050-0001	*	*	20-B

KOMATSU

VEÍCULO	MOTOR	HDM BIAGIO	MOD. BIAGIO	O.E.M.	P/N GARRET	P/N BORG W.	P/N HOLSET	PÁG. FOTO
PÁ CARREGADEIRA WA320/ GB629/ GD623/PC 150/37 / E PC 150-5D60A	CUMMINS 6CT - 8.3L	100NT	TUNA 30	*	465843-5001	175528	3590079	17-H
TRATOR DE ESTEIRAS PC150-5TE/D50E/D50A	OM352A	100WA	TUNA 30	*	409300-0001	312342	3580252	22-D
GD523/GD525/ PC150/3/ PC150/5	CUMMINS 6BT0007/9 5.9L	170BT	TUNA 30	*	466563-5003	166592	3528741	23-C
PÁ CARREGADEIRA WA200/ 250/ MOTO-NIVELADORA / GD405/ GD555/ GERADOR DCA125/ ESCAVADEIRA PC200/ INDUSTRIAL	CUMMINS 6BTAA	170KT	TUNA 30	*	*	*	4038475/ 3785477	23-D
WA150/200/ PC200/228UU/ WA100	CUMMINS 6BT/ C SERIES D58/ S6D102/ SA6D102	170LT	TUNA 30	3802862/ 4024865 6738-81-8200 /8300/8400	*	*	3537019/ 3537020 3536339/ 3593211	23-E

LS TRACTOR

VEÍCULO	MOTOR	HDM BIAGIO	MOD. BIAGIO	O.E.M.	P/N GARRET	P/N BORG W.	P/N HOLSET	PÁG. FOTO
PLUS 90/ 100	TD229-4	267CT	TUNA 10	*	704944-5001	197332	*	19-A

MAHINDRA

VEÍCULO	MOTOR	HDM BIAGIO	MOD. BIAGIO	O.E.M.	P/N GARRET	P/N BORG W.	P/N HOLSET	PÁG. FOTO
9200 / 9500S	NE 495-TC	420AT	TUNA 09	836747517 / 836764049	*	312770/ 170429 / 770429	*	20-E

MASSEY FERGUSON / PERKINS

VEÍCULO	MOTOR	HDM BIAGIO	MOD. BIAGIO	O.E.M.	P/N GARRET	P/N BORG W.	P/N HOLSET	PÁG. FOTO
COLHEITADEIRA MF5650 / ESTACIONÁRIO / TRATOR MF MX9150 / MX9170 / MF299 / TRATOR MF296/TR4 (P/KIT)	6354/6 / LT6354.4 / T 6354.4 / ALT6354.4 / AT6354.4 / 6.354	084KT	TUNA 30	79014/ 79015/ 79017	702368-5002/ 702366-5001/ 702366-5002/ 702368-5002	*	*	16-F
COLHEITADEIRA MF5650 /6845 / MF 680 (S/VALVULA)	PERKINS 1006-6T TURBO / PERKINS 1000	084LT	TUNA 30	*	452024-5003	*	*	16-G
MF 650/ MF660	PERKINS 1006-6T	084NT	TUNA 20	2674A166	*	16658	*	16-H
TRATOR	698T / T6354.4	084PT	TUNA 20	2674358/ 2674364	465960-0001	*	*	17-A
TRATOR 295/ 296/ 296TR4	6358 (P/KIT)/6354-4 (P/KIT) / 6358 (P/ KIT)	100ET	TUNA 20	*	*	*	*	17-D
TRATOR MF 295 /MF 296/ 296TR4	6358/ 6354-4	100GT	TUNA 10	*	465813-5001	*	*	17-E
COLHEITADEIRA MF34	CUMMINS 6CT - 8.3L	100NT	TUNA 30	*	465843-5001	*	3590079	17-H
TRATOR 4707/ 4708/ 4709/ 5709/ 5710	AGCO POWER - 3 CILINDROS	102GT	TUNA 08	836659179	*	715920	*	18-A
INDUSTRIAL	1006TGA	106PT	TUNA 30	*	452234-0006	*	*	22-F
BUTSAN	PHASER	109AT	TUNA 09	*	758817-0001	*	*	18-C
275/ 290	4236/ 4248/ Q20b4236V	267CT	TUNA 10	*	704944-5001	*	*	19-A
TRATOR MF 292	AT4.236	267HT	TUNA 10	79007	5111210016 5111210014	*	*	19-C
JCB 214E	T4.40	267XT	TUNA 10	2674394 / 2674A160	466854-0001	*	*	23-H
INDUSTRIAL	1004 2T	267YT	TUNA 10	2674399 / 2674A140	466674-0001	*	*	19-D
TRATOR MF 292	P4000T	292AT	TUNA 10	79022	704945-5003	*	*	19-E
TRATOR	ASP. ADAP A/R.48	314AT		*	*	*	*	19-G
COLH. MF5650 ATÉ 88	AT6.354.4	354BT	TUNA 20	2674152	465154-5001	310407	*	20-C
COLHEITADEIRA / INDUSTRIAL	AC635.4 / C6354.4	506AT	TUNA 20	2674367	465154-0008 465154-5008	311521	*	20-F

METASA

VEÍCULO	MOTOR	HDM BIAGIO	MOD. BIAGIO	O.E.M.	P/N GARRET	P/N BORG W.	P/N HOLSET	PÁG. FOTO
TRATOR URSUS 6012/6014	6012 4X2 / 6014 4X4	050AT	TUNA 20	*	466394-5002	*	*	16-A

MÜLLER

VEÍCULO	MOTOR	HDM BIAGIO	MOD. BIAGIO	O.E.M.	P/N GARRET	P/N BORG W.	P/N HOLSET	PÁG. FOTO
TRATOR	MWM D229/6	084VT	TUNA 20	*	465744-5006	169124	*	17-B
TM17/TM25/TM26/TC18	CUMMINS 6CT	100NT	TUNA 30	*	465843-5001	*	3590079	17-H
TM14/T5-22/VAP-0C/ VAP-70P	CUMMINS 6BT0003 /19/18/ 16 5.9L	170BT	TUNA 30	*	466563-5003	166592	3522778 3528741	23-C

NEW HOLLAND

VEÍCULO	MOTOR	HDM BIAGIO	MOD. BIAGIO	O.E.M.	P/N GARRET	P/N BORG W.	P/N HOLSET	PÁG. FOTO
TC59	GENESIS	059AT		87801427 / 87841189	452159-0001	*	*	16-B
TL 85/90/100	IVECO 8045	085AT		4814851/ 4817756	466698-0001	*	*	17-C

RANDON

VEÍCULO	MOTOR	HDM BIAGIO	MOD. BIAGIO	O.E.M.	P/N GARRET	P/N BORG W.	P/N HOLSET	PÁG. FOTO
RANDON RD 406	MWM 4.10T	267FT	TUNA 10	905292010039	465837-5001	*	*	23-G

SCANIA

VEÍCULO	MOTOR	HDM BIAGIO	MOD. BIAGIO	O.E.M.	P/N GARRET	P/N BORG W.	P/N HOLSET	PÁG. FOTO
COLHEITADERA / INDUS-TRIAL	DS11/34/36 /DS11 34B03 /DS11 34B06	134AT	TUNA 44	1114891/ 1115749/ 1114892 /1673063/ 1671731/ 1677955/ 1115567	465213-0002/03 465213-0001/04	170404 312283	3531719	18-D

VALTRA / VALMET

VEÍCULO	MOTOR	HDM BIAGIO	MOD. BIAGIO	O.E.M.	P/N GARRET	P/N BORG W.	P/N HOLSET	PÁG. FOTO
GRUPO GERADOR / TRATOR 1580/1780 MODERNO /1880 APÓS 94 / TRATOR 1780 4X4 / TRATOR 980 4X4	MWM 6.10T/TD229-6/ TD229/4TS/4EC4	084GT	TUNA 30	9.0529.20. 1.0032	702154-5002 465803-5001	169144	*	16-E
A1380S/1680S/ 1885S/ BH145/BH165/BH180/ BT150/ BT170/ BH185I/ BH205I/TRATOR 138 ATÉ MAIO 93/ 138/140/148 /1580/1780/ 138/140/ 148/1580/ 1780/ 138/148	620DS/ 620DSA/ MWM TD229/6 TD229-6/ TD229-6/ MTD299/6/ TD229/ EC6	084VT	TUNA 20	*	465744-5006 465744-5005	166595/ 169124/ 198684	*	17-B
TRATOR VALTRA/VALMET A750E / A750 / A850 / A950 / BF75 / BL77 / BL88 / 700	320DS / 420DS	102GT	TUNA 08	836659179	*	715920	*	18-A
TRATOR 980 4X4/985 4X4 TURBO / TRATOR 980 ATÉ MAIO 93	MWM TD229/ 4TS/4EC4	267DT	TUNA 10	9.0 529.20 .1.0017	465803-5001	*	*	19-B
TRATOR VALTRA/VALMET BM100 / BM110 / BM125I / A.885S/985SO	420DSR 420DSRA E 420DS	420AT	TUNA 09	836747517 /836764049	*	312770 / 170429 770429	*	20-E

VOLVO

VEÍCULO	MOTOR	HDM BIAGIO	MOD. BIAGIO	O.E.M.	P/N GARRET	P/N BORG W.	P/N HOLSET	PÁG. FOTO
A25C/L120B/CL90B	TD73/ TD73K/ TD73KCE/ TD63	073AT	TUNA 30	*	466742-0010	*	*	22-A
G710/ G710VHP	6B5.9	35W5	TUNA 30	3802767	*	*	353671	24-D



LINHA AGRÍCOLA



A

HDM 050AT

MONTADORA(S): CBT
 MOTOR: MWM D229/4
 VEÍCULO(S): TRATOR 8440
 (ADAPT.)
 P/N GARRETT: 466394-5002
 MOD.: TB4125



B

HDM 059AT

MONTADORA(S): NEW HOLLAND
 MOTOR: GENESIS
 VEÍCULO(S): COLHEITADEIRA
 TC59
 P/N GARRETT: 452159-0001 /
 452159-0002
 MOD.: GT3776
 O.E.M.: 87801427 / 87841189



C

HDM 084CT

MONTADORA(S): FORD NEW
 HOLLAND
 MOTOR: MOTOR FORD
 VEÍCULO(S): TRATOR 8630/8830
 P/N GARRETT: 465114-5005
 MOD.: TO4B66



D

BBV 084IT

MONTADORA(S): MERCEDES-BENZ
 MOTOR: OM366LA TODOS
 VEÍCULO(S): CAMINHÃO 1218 /
 1418 / 1718 / 1620 / 1620 / 1721
 / 1621 / 1618 / 2318 / 1720 /
 1318 / 1723 / ÔNIBUS O371 /
 OF1620 / OF1318 / OH1620 /
 OH1621 / OH1721 / 364 MOTOR
 TRASEIRO / 365 MOTOR TRASEIRO
 APOS 85 / 365 MOTOR DIANTEIRO
 ATÉ 85
 P/N GARRETT: 466646-5041
 MOD.: TO4E66
 P/N BORG: 169146
 MOD.: S2EL-004
 P/N HOLSET: 3580266



E

HDM 084GT

MONTADORA(S): VALTRA/
 VALMET
 MOTOR: MWM 6.10T/TD229-6/
 TD229/4TS/4EC4
 VEÍCULO(S): GRUPO GERA-
 DOR / TRATOR 1580/1780
 MODERNO / 1880 APOS 94 /
 TRATOR 1780 4X4 / TRATOR 980
 4X4/985 4X4 TURBO / TRATOR
 980 ATÉ MAIO 93 / TRATOR 985
 ATÉ JUNHO 93
 P/N GARRETT: 702154-
 5002/465803-5001
 MOD.: TO4E
 P/N BW: 169144
 MOD.: S2EL-064
 O.E.M.: 9.0529.20.1.0032



F

HDM 084KT

MONTADORA(S): MASSEY
 FERGUSON
 MOTOR: 6354/6 / LT6354.4 / T
 6354.4 / ALT6354.4/AT6354.4
 / 6.354
 VEÍCULO: COLHEITADEIRA
 MF5650 / ESTACIONÁRIO /
 TRATOR MF MX9150 / MX9170
 / MF299 / TRATOR MF296/TR4
 (P/KIT)
 P/N GARRETT: 702368-5002/
 702366-5001 / 702366-5002/
 702368-5002/
 MOD.: TO4E



G

HDM 084LT

MONTADORA(S): MASSEY
 FERGUSON
 MOTOR: PERKINS 1006-6T
 TURBO / PERKINS 1000
 VEÍCULO: COLHEITADEIRA
 MF5650 / 6845 / TRATOR MF
 680 (TURBO S/VALVULA)
 P/N GARRETT: 452024-5003
 MOD.: TBP4



H

HDM 084NT

MONTADORA(S): MASSEY
 FERGUSON
 MOTOR: PERKINS 1006-6T
 VEÍCULO: TRATOR MF 650/
 MF660
 P/N BORG: 16658
 M.O.D.: S2EL020
 O.E.M.: 2674A166

A

**HDM 084PT**

MONTADORA(S): LEYLAND
DAF / PERKINS
MOTOR: 698T / T6354.4
VEÍCULO(S): VÁRIOS
P/N GARRETT: 465960-0001
MOD.: TO4B58

B

**HDM 084VT**

MONTADORA(S): FIAT/ALLIS, MÜLLER,
VALTRA/VALMET
MOTOR: 620DS/ 620DSA/ MWM
TD229/6/ MWM TD229-6/ MWM
TD229-6/ MWM MTD299/6/ MWM
TD229/EC6
VEÍCULO(S): A1380S/1680S/1885S/
BH145/BH165/BH180/ BT150/
BT170/ BH1851 / BH205I/ TRA-
TOR 138 ATÉ MAIO 93/ TRATOR
138/140/148/1580/1780/ TRATOR
138/140/148/ 1580/1780/ TRATOR
138/148/140 4X4/ 1580/1780 4X4
TURBO/ TRATOR 1580 /
1680 / 1780 ATÉ 93/ TRATOR 1680 /
1780 ATÉ JUNHO 93
P/N GARRETT: 465744-5006/
465744-5005
P/N BW: 166595/169124/198684

C

**HDM 085AT**

MONTADORA(S): NEW HOLLAND
MOTOR: IVECO 8045
VEÍCULO(S): TL 85 / 90 / 100
P/N GARRETT: 466698-0001 /
466698-0002
MOD.: TA3118
O.E.M.: 4814851 / 4817756

D

**HDM 100ET**

MONTADORA(S): MASSEY
FERGUSON
MOTOR: 6358 (P/ KIT) / 6354-
4 (P/ KIT) / PERKINS 6358 (P/
KIT)
VEÍCULO(S): TRATOR 295/
296/ 296TR4

E

**HDM 100GT**

MONTADORA(S): MASSEY
FERGUSON
MOTOR: 6358/ 6354-4
VEÍCULO: TRATOR MF 295/
TRATOR MF 296/ 296TR4
P/N GARRETT:465813-5001
MOD.: TO4EBR

F

**BBV 100JT**

MONTADORA: FORD
MOTOR: MWM 6.10 (X10)
VEÍCULO: NEW HOLLAND
8630/8830 / ESTACIONÁRIO /
MARÍTIMO
P/N GARRETT: 702154-5003S/
702154-5001
MOD.: TO4E
P/N BORG: 169144
MOD.: S2EL-064
P/N HOLSET: 3580560
MOD.: H1C

G

**HDM 100MT**

MONTADORA(S): IVECO/ FORD
NEW HOLLAND
MOTOR: IVECO/ 8060.25
VEÍCULO(S): TRATOR 8430/ FIAT
150 T/ 150 BRASIL
P/N GARRETT: 465640-5022/
465640-5013
MOD.: TO4B49
P/N BORG: 169125
MOD.: S2EL-205
O.E.M.: 4762527/ 4810230

H

**HDM 100NT**

MONTADORA(S): MASSEY
FERGUSON
MOTOR: CUMMINS 6CT - 8.3L
VEÍCULO: COLHEITADEIRA
MF34
P/N GARRETT: 465843-5001
P/N HOLSET: 3590079

A



HDM 102GT

MONTADORA(S): VALTRA/
VALMET
MOTOR: 320DS / 420DS
VEÍCULO(S): A750E / A750 /
A850 / A950 / BF75 / BL77 / BL88
/ 700 / 4707 / 4708 / 4709 / 5709 /
5710
O.E.M.: 836659179
P/N BORG: 715920

B



HDM 107ET

MONTADORA(S): FORD NEW
HOLLAND
MOTOR: 4.4L
VEÍCULO(S): TRATOR 7610
P/N GARRETT: 466746-5003
MOD.: TA31
O.E.M.: E6NN-6K682AA

C



HDM 109AT

MONTADORA(S): PERKINS
MOTOR: PHASER
VEÍCULO(S): BUTSAN
P/N GARRETT: 758817-0001
MOD.: GT2558

D



HDM 134AT

MONTADORA(S): SCANIA
MOTOR: DS11/34/36 DS11
34B03 / DS11 34B06
VEÍCULOS: COLHEITADERA/
INDUSTRIAL
P/N GARRETT: 465213-0002/03/
465213-0001/04
MOD.: TA4536
P/N BORG: 170404 / 312283
MOD.: S400-205 / S3A
P/N HOLSET: 3531719
MOD.: H2D
O.E.M.: 1114891 / 1115749 /
1114892 / 1673063 / 1671731 /
1677955 / 1115567

E



HDM 150MT

MONTADORA(S): IVECO
MOTOR: 8060.24.661 / 8065.24
VEÍCULO(S): TRACTOR
P/N GARRET: 465640-002/465640-5005
/465640-5021
MOD. GARRET: TO4B49
P/N O.E.: 465640-0005 / 465640-0021
MOD. O.E.: TO4B49

F



HDM 220AT

MONTADORA(S): FORD NEW
HOLLAND
MOTOR: FORD
VEÍCULO(S): FB100 / FB110 /
FB100.2 / FB110.2 / TB100 / TB80 /
TS100 / TS110 / 7630 / 7840 /
2550 SPEEDROWER / 4630 /
5030 / 5630 / 6610S / 6630 /
7010 / 7740 / 8030
P/N GARRETT: 465153-0003
MOD.: T250-01
O.E.M.: 83999247 /
FONN6K682BA

A



HDM 267CT

MONTADORA(S): FORD NEW HOLLAND /
MASSEY FERGUSON / PERKINS
MOTOR: 4236 / 4248 / Q20B4236V / TD229-4
VEÍCULO(S): TRATOR MF 275 / 290 / PLUS
90/ 100
P/N GARRETT: 704944-5001/ 704944-5002
MOD.: TA31
P/N GARRET: 704944-5001
MOD.: TA31 / APL-240 ANTIGO
P/N BORG: 197332/198644
MOD.: S2A-204/ S2A-101
P/N HOLSET: 3524709
MOD.: H1C

B

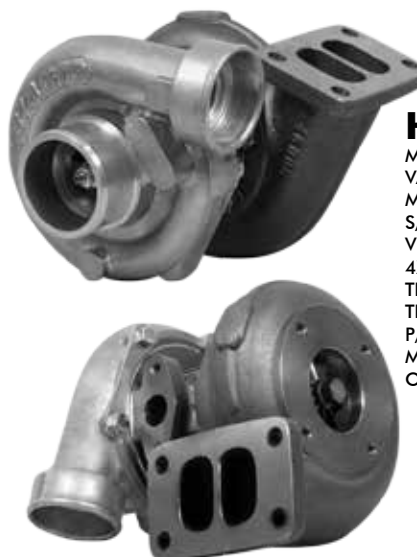

HDM 267DT

MONTADORA(S): VALTRA/
VALMET
MOTOR: MWM TD229/4T-
S/4EC4
VEÍCULO(S): TRATOR 980
4X4/985 4X4 TURBO /
TRATOR 980 ATÉ MAIO 93 /
TRATOR 985 ATÉ JUNHO 93
P/N GARRETT: 465803-5001
MOD.: TA3129
O.E.M.: 9.0529.20.1.0017

C



HDM 267HT

MONTADORA(S): MASSEY
FERGUSON
VEÍCULO(S): TRATOR MF 292
MOTOR: AT4.236
P/N GARRETT: 5111210016/
5111210014
MOD.: TA31
O.E.M.: 79007

D



HDM 267YT

MONTADORA(S): PERKINS
ESTACIONÁRIO
MOTOR: 1004 2T
VEÍCULO(S): INDUSTRIAL
P/N GARRETT: 466674-0001 /
466674-0002
MOD.: T3123

E



HDM 292AT

MONTADORA(S): MASSEY FERGUSON
MOTOR: P4000T
VEÍCULO(S): TRATOR MF 292
P/N GARRETT: 704945-5003

F



HDM 300ST

MONTADORA(S): JOHN DEERE
MOTOR: 6090H
VEÍCULO(S): COLHEITADEIRA 3520

G



HDM 314AT

MONTADORA(S): MASSEY FERGUSON
MOTOR: ADAPTAÇÃO TRATOR ASPIRA-
DO - CARÇAÇA A/R .48
VEÍCULO(S): TRATOR

A



HDM 350AT

MONTADORA(S): JOHN DEERE
 MOTOR: 6068TJ-01/ 6059TJ-02/
 6059TJ-03/ 6559TJ-04
 VEÍCULO(S): 84/ 7500/ 7505/
 7600/ 7800/ 1165A/ 1175A
 780AG/ MPE/ MW3Q
 P/N GARRETT: 466007-5006/
 466007-5001
 MOD.: T350-01
 O.E.M.: RE56617

B



HDM 350BT

MONTADORA(S): JOHN DEERE
 MOTOR: 6068T (116/137CV)
 VEÍCULO(S): 350 SERIES -HI
 MOUNT/ ESCAVADEIRA 350
 P/N GARRETT: 471050-0001 |
 MOD.: T350-04
 P/N BORG: 177263 | MOD.:
 S200
 O.E.M.: RE60074/ RE60388

C



HDM 354BT

MONTADORA(S): MASSEY FERGUSON
 MOTOR: AT6.354.4
 VEÍCULO: COLHEITADEIRA
 MF5650 ATÉ 88
 P/N GARRETT: 465154-
 5001
 MOD.: TO4B71
 P/N BORG: 310407 | MOD.:
 S76
 O.E.M.: 2674152

D



HDM 40XW5

MONTADORA: J.I. CASE E NEW HOLLAND
 MOTOR: 6CTAA
 VEÍCULO(S): MAGNUM 220/ 240/
 270/ 305
 MAGNUM MX220/ MX240 /
 MX270/ CS660/ 2388
 P/N HOLSET: 3537762
 MOD.: HX40W
 O.E.M.: J537762/ J594800/
 3802888

E



HDM 420AT

MONTADORA(S): VALTRA/
 VALMET
 MOTOR: 420DSR, 420DSR,
 420DSRA E 420DS / NE
 495-TC
 VEÍCULO(S): TRATOR
 VALTRA/VALMET BM100 /
 9200 / 9500S/ BM110 /
 BM1251 / A.885S/985SO
 P/N BORG: 312770 /
 170429 / 770429
 MOD.: S1B

F



HDM 506AT

MONTADORA(S): MASSEY FERGUSON / PERKINS
 MOTOR: AC6354.4 /
 T6354.4 MIL
 VEÍCULO(S): INDUSTRIAL /
 COLHEITADEIRA
 P/N BORG.: 311521
 MOD.: S76
 P/N GARRET: 465154-
 0008
 MOD.: TO4B71



LINHA CONSTRUÇÃO

A



HDM 073AT

MONTADORA(S): VOLVO
MOTOR: TD73 / TD73K /
TD73KCE/ TD63
VEÍCULO(S): A25C /
L120B/C /L90B
P/N GARRETT: 466742-
0010
MOD: TO4E10

B



HDM 078CT

MONTADORA(S): CATER-
PILLAR
MOTOR: 3116DIT
VEÍCULO(S): PATROL 112H
ESCAVADEIRA 325
P/N BORG: 199288
O.E.M.: 0R6240/4P5523

C



HDM 100FB

MONTADORA(S): MERCE-
DES-BENZ E J.I. CASE
MOTOR: OM366A /
OM352A TODOS
VEÍCULO(S): PÁ CARRE-
GADEIRA W20D / D20E
/ TRATOR DE ESTEIRAS
D50A
P/N GARRETT: 465366-
5013 | MOD: TO4B81
P/N BORG: 313050 |
MOD: S2B
P/N HOLSET: 3580266

D



HDM 100WA

MONTADORA(S): J.I. CASE
E KOMATSU
MOTOR: OM352A
VEÍCULO(S): PÁ CARREGA-
DEIRA W20/W20B TRATOR
DE EST. PC 150-5T6 / D50E
/ D50A
P/N GARRETT: 409300-
0001 | MOD: TO4B27
P/N BORG: 312329 |
MOD: 3LKS
P/N HOLSET: 3580252

E



HDM 106AT

MONTADORA(S): FORD
MOTOR: CUMMINS 4BT
VEÍCULO(S): 580L
P/N HOLSET: 3536838 /
3535381
MOD.: H1C
OEM: J802290

F



HDM 106PT

MONTADORA(S): PERKINS
MOTOR: INDUSTRIAL
VEÍCULO(S): 1006TAG
P/N GARRETT: 452234-
0006

G



HDM 108GT

MONTADORA(S): CATER-
PILLAR
MOTOR: 3306
VEÍCULO(S):
P/N BORGWARNER:
184662
MOD.: 4LE-302

H



BBV 111AT

MONTADORA(S): M BENZ
MOTOR: OM355/6A - DS11
VEÍCULO(S): INDUSTRIAL/ ESTA-
CIONÁRIO
P/N GARRETT: 465990-5013/
0007/ 0012/ 5007 | MOD.:
TV6114
P/N BORG: 182296/ 510833/
510855/ 312043/ 185576/
510845/ 6232 988 3279 | MOD.:
4LGZ/ 4LE/ 4LGZ352/ 4LGZ9944/
4LBR566/ 4LGZ355/ 4LE32
P/N HOLSET: 3525150/ 3525154
O.E.M.: 10964799/ 10962199/
28173064/ 5000787889/ 532530/
543063/ 250248/ 257747/
252320/ 301249/ 301250/
279136/ 261408/ 310582/
375500/ 305720/ 10962499/
51091007147



A

BBV 112AT

MONTADORA(S):
SCANIA
MOTOR: DSC11 /
DS1132B01
VEÍCULO(S): CAMI-
NHÃO 112 ATÉ 89 /
K112 / K113 MOTOR
TRASEIRO / KT112 / T /
R-112HS / MA / E / H
P/N GARRETT: 716639-
5001 | MOD: TV6114
P/N BORG: 510957 |
MOD: 4LGZ-9944
P/N HOLSET: 3504412



B

HDM 152CAT

MONTADORA(S): CATER-
PILLAR
MOTOR: 3304 / 3304DIT
VEÍCULO(S): 950B / 955X /
D5X / 130G / 9308 / 555 /
229 / 936E / 963 / D4E-SA /
GERADOR
P/N GARRETT: 409410-0008
O.E.M.: 7N4651G / 7N9851 /
1W5160G / 7N1709



C

HDM 170BT

MONTADORA(S): MÜLLER
/ J.I. CASE
MOTOR: 6BT0003/16 /
18 / 19
VEÍCULO(S): TM14/T5-22/
VAP-0C / VAP-70P
P/N GARRETT: 466563-
5003 | MOD: TA34
P/N BORG: 166592 |
MOD: S2EL209
P/N HOLSET: 3534285
/ 3528741 / 3522778 /
3528741



D

HDM 170KT

MONTADORA(S): KOMATSU
MOTOR: CUMMINS 6BTA
VEÍCULO(S): PÁ CARRE-
GADEIRA WA200/250/
MOTONIVELADORA
GD405/ GD555/ GERADOR
DCA125/ ESCAVADEIRA
PC200/ INDUSTRIAL
P/N HOLSET: 4038475/
3785477 MOD.: HX35
O.E.M.: 4089711
O.E.: 4038480/ 4038481/
4036172/ 4039243/
4035374/ 3785478/
3788390/ 3788391



E

HDM 170LT

MONTADORA(S): KOMATSU
MOTOR: CUMMINS 6BT/
C SERIES D58/ S6D102/
SA6D102
VEÍCULO(S): WA150/200/
PC200/228UU/WA100
P/N HOLSET:
3537019/ 3537020/
3536339/3593211
MOD.: HX35
O.E.M.:
3802862/4024865/6738-
81-8200/8300/8400



F

HDM 175AT

MONTADORA(S): CATER-
PILLAR
MOTOR: 3304/3304DIT
VEÍCULO(S):
120G/950/518/E207/
E240MHI/120G/225/SMFS
P/N GARRETT: 409410-
0002*
O.E.M.: 4N6858/4N-
6859G/4N9714



G

HDM 267FT

MONTADORA(S): FORD
MOTOR: MWM 4.10T
VEÍCULO(S): RANDON
RD 406
P/N GARRETT: 465837-
5001
MOD: TA31



H

HDM 267XT

MONTADORA(S): PERKINS
MOTOR: T4.40
VEÍCULO(S): JCB 214E
P/N GARRET: 466854-0001
MOD: T3120



A

HDM 315AT

MONTADORA(S): CATERPILLAR
 MOTOR: 3046
 VEÍCULO(S): ESCAVADEIRA 315C / 312C / 312L
 O.E.M.: 1166709 / 1177867



B

HDM 319AT

MONTADORA(S): CATERPILLAR
 MOTOR: CAT3306
 VEÍCULO(S): D6D-966C / 120G / 140G
 P/N GARRETT: *
 P/N BORG: 310130 / 159623 / 180189
 O.E.M.: 4N8969



C

HDM 320AT

MONTADORA(S): CATERPILLAR
 MOTOR: 3066
 VEÍCULO(S): ESCAVADEIRA 320B / 320C / 320L
 O.E.M.: 517582 / 517952 / 518018



D

BBV 35W5

MONTADORA(S): CUMMINS / VOLVO
 MOTOR: 6BT INDUSTRIAL / 6B5.9
 VEÍCULO(S): G710 / G710VHP
 P/N HOLSET: 35367
 MOD.: HX35W
 O.E.M.: 3802767 O.E.: 3536976



E

HDM 373AT

MONTADORA(S): CATERPILLAR
 MOTOR: 3306
 VEÍCULO(S): 140G / D6D-DD / 966C
 P/N BORG: 184119 / 310135
 O.E.M.: 0R5807 / 7N7748



F

HDM 373BT

MONTADORA(S): CATERPILLAR
 MOTOR: 3306
 VEÍCULO(S): 3306
 P/N BORG: 185841 / 313092
 O.E.M.: 0R5811 / 8N9247



G

HDM 416AT

MONTADORA(S): CATERPILLAR / MASSEY FERGUSON
 MOTOR: PERKINS 4.4L 85/117 - 1104C -44T
 VEÍCULO(S): 416E
 P/N: 711736-0026 / 711736-5026
 MOD.: GT2556
 O.E.M.: 237-3786 / 2674A226 - 2674A432 / 2674A877



H

HDM 504CT

MONTADORA(S): CATERPILLAR
 MOTOR: 3306
 VEÍCULO(S): *
 P/N BORG: 180287
 O.E.M.: 4N9618

**A****HDM 580AT**

MONTADORA(S): NEW HOLLAND / CASE
MOTOR: 4BT
VEÍCULO(S): CASE 580M
NEW HOLLAND LB110
P/N: 4039339 / 4039338
MOD.: HX30

**B****HDM 924FT**

MONTADORA(S): CATERPILLAR
MOTOR: 3114 924F / T24F
VEÍCULO(S): CAT. IDS
P/N BORG: 317817/
467560
O.E.M.: 114-3601 / 114-3601E / OR6900

**C****HDM 940AT**

MONTADORA(S): CATERPILLAR
MOTOR: PERKINS T6.60
VEÍCULO(S): CARREGADEIRA 924G
P/N GARRETT: 452234-5001
O.E.M.: 2674A090



**CONHEÇA
TAMBÉM
OS NOSSOS
PRODUTOS PARA A
LINHA MARÍTIMA**

• **TURBOS** | • **MUFLAS** | • **CAMISA REFRIGERADA**



BIAGIO
TURBOS

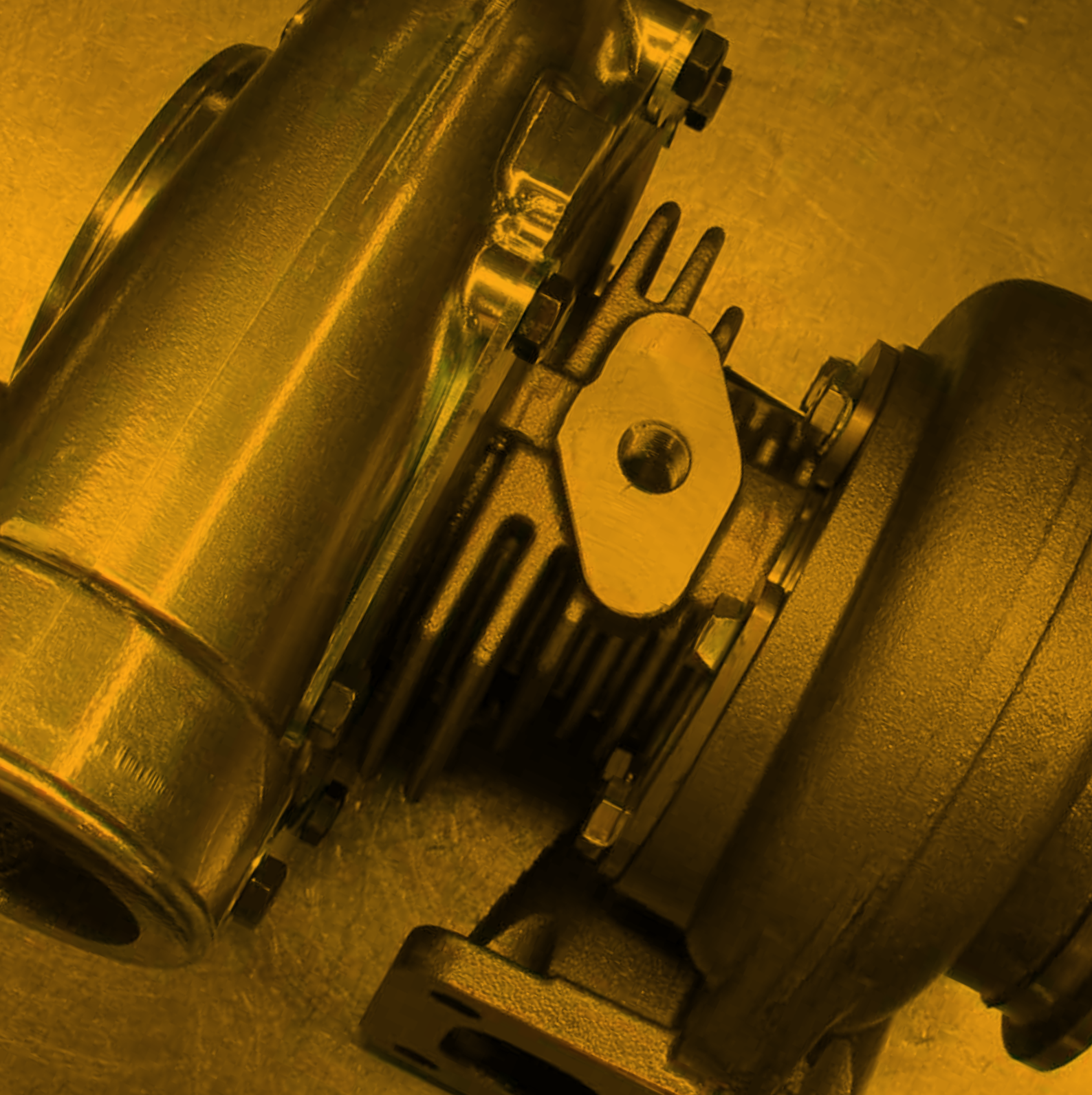

BIAGIO **TURBOS**

SÃO JOÃO DA BOA VISTA | SÃO PAULO | BRASIL
WWW.BIAGIOTURBOS.COM

